

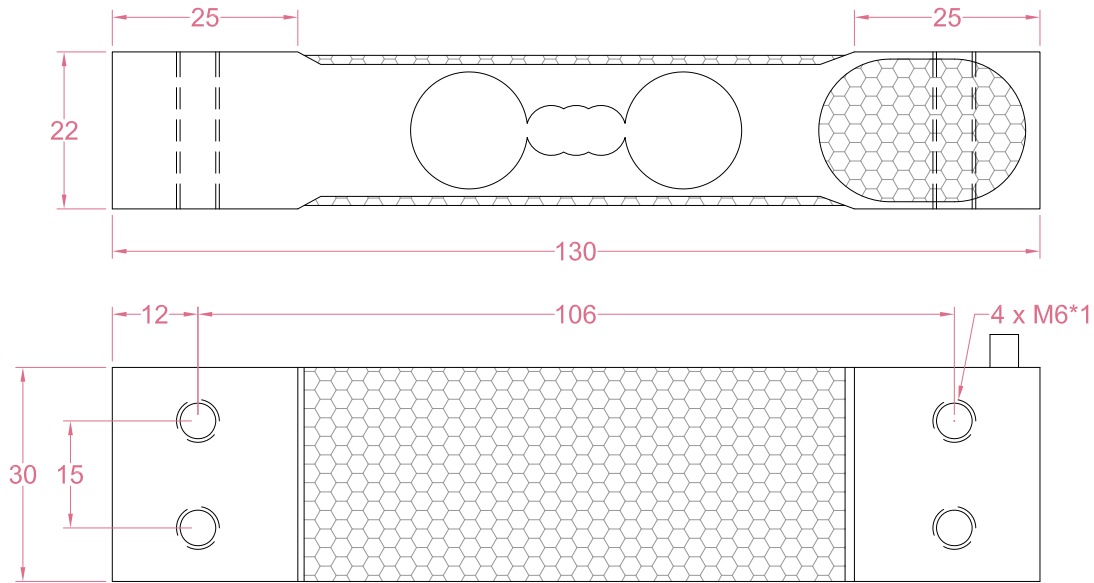

Dimensions in "mm"



Order example:

2 x LCE10 - 10kg

Quantity

Model

Capacity

Email to sales@loadcellsensor.com for a quote

Specifications

Rated Capacity	3/6/10/20/40 kg		
Rated Output	2.0±0.2 mV/V	Compensated Temp.	-10...+40°C
Excitation	3~15V	Operating Temp.	-20...+60°C
Zero Balance	±0.1 mV/V	Temp. Coeff. of Zero	±0.002% F.S./°C
Nonlinearity	±0.018% F.S.	Temp. Coeff. of Span	±0.002% F.S./°C
Hysteresis	±0.018% F.S.	Input Resistance	405±10 Ohms
Nonrepeatability	±0.01% F.S.	Output Resistance	352±5 Ohms
Creep(30min)	±0.02% F.S.	Insulation Resistance	>2000M Ohms(50V)
Safe Load Limit	150% F.S.	IP Rating	IP65
Breaking Load	180% F.S.	Element Material	Aluminum alloy
Cable	Ø4*400mm 4-conductor shielded cable		

• LCS reserves the right to modify its design and specifications without notice

P:1/2



Load direction

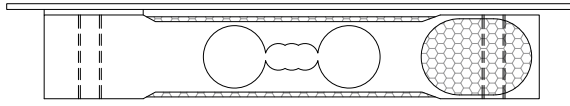

Suitable for off center load measurement.
Platform size goes up to 250x350mm

Wiring Code

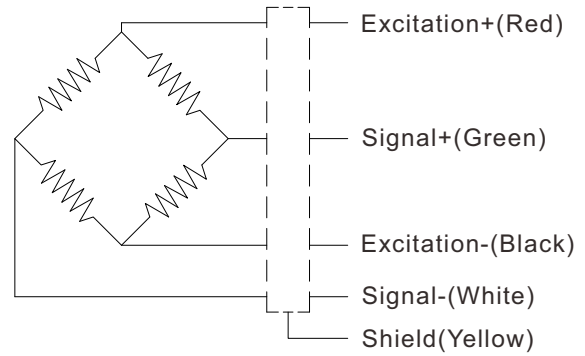

Shield is NOT connected to the sensor body

Sensor/Amplifier/Indicator

Items	Power supply	Output/Function
LCE10	3-15V (Constant)	0mV...+30mV (Depending on the power supply)
LCE10 + Analog amplifier	12~24V DC	0-3.3V,0-5V,0-10V, 0-20mA,4-20mA...
LCE10 + Digital amplifier	12~24V DC	RS485 or RS232 output
LCE10 + Indicator	12~24V DC	Display force value Switch/Relay output Peak holding RS485/RS232 interface 0-5V/0-10V/4-20mA output
Email us for datasheet of amplifier and indicator		