

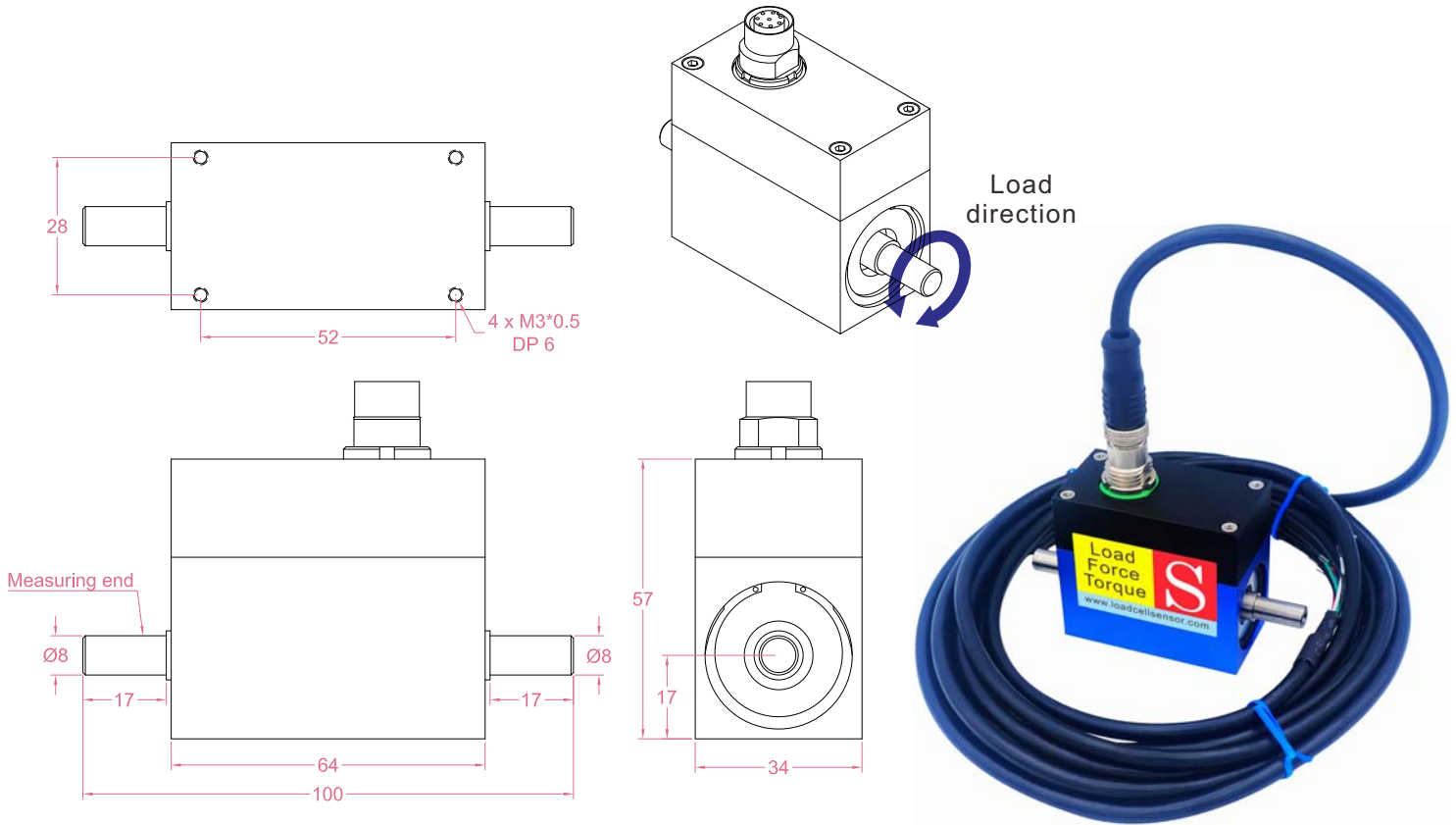

Dimensions in "mm"



Specifications	
Torque Capacity	0.1/0.2/0.5/1/2/3/5 NM
Speed Capacity	Up to 8000RPM
Power Supply	12 or 24V DC
Rated Output	Refer to ordering part No.
Sampling Rate	500Hz
Nonlinearity	±0.2% F.S.
Hysteresis	±0.2% F.S.
Nonrepeatability	±0.2% F.S.
Creep(5min)	±0.1% F.S.
Safe Torque Limit	150% F.S.
Breaking Torque	200% F.S.
Operating Temp.	-10...+60°C
IP Rating	IP40
Element Material	Stainless steel
Housing Material	Aluminum alloy
Cable	Ø6*5000mm with mating connector

• LCS reserves the right to modify its design and specifications without notice





Cable Options

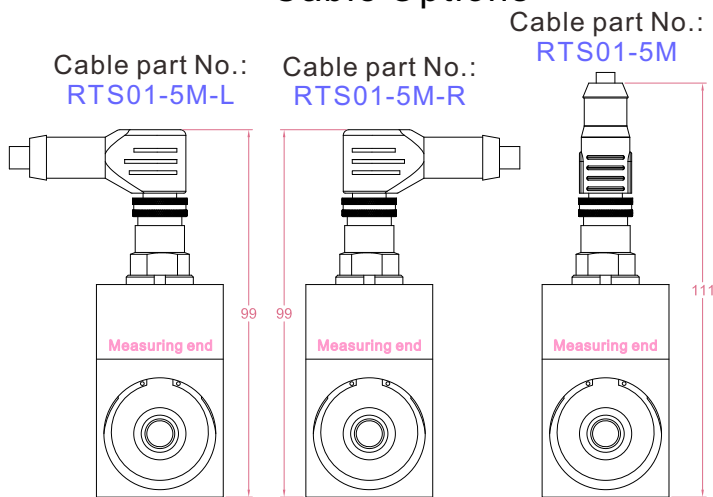

Display Options

Model: **RTS01**
(Without display)

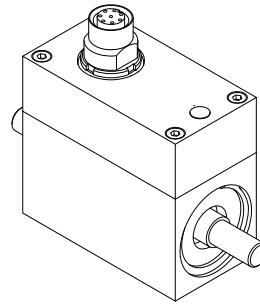

Model: **RTS01A**
(With display)

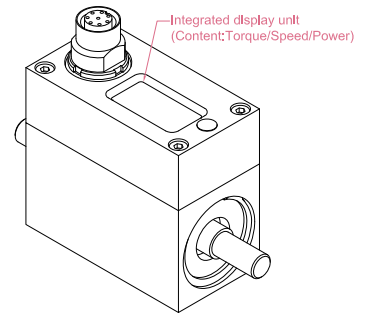

Ordering part No.

Torque Measurement Only					
Ordering part No.: Model - Torque capacity - Code					
Model	Torque cap. (Nm)	Code	Power supply	Torque output	
RTS01 RTS01A	0.1 0.2 0.5 1 2 3 5	A	24V DC	-3.3-3.3V	
		B		0-1.65-3.3V	
		C		-5-5V	
		D		0-2.5-5V	
		E		-10-10V	
		F		0-5V-10V	
			G	12V DC	4-12-20mA
			H		-3.3-3.3V
			I		0-1.65-3.3V
			J		-5-5V
			K		0-2.5-5V
			L		4-12-20mA

Example: **RTS01-0.1-C** means:
Model: RTS01(Without display unit)
Power supply: 24V DC
Torque channel: -0.1Nm~0.1Nm VS -5-5V

Wiring code	
Red	Power+
Black	Power-
Green	Torque output+
White	Torque output-
Yellow	Shield

Torque And Speed Measurement							
Ordering part No.: Model - Torque capacity - Speed capacity - Code							
Model	Torque cap. (Nm)	Speed cap. (RPM)	Code	Power supply	Torque output	Speed output	
RTS01 RTS01A	0.1 0.2 0.5 1 2 3 5	0~8000	A	24V DC	-3.3-3.3V	0-3.3V	
			B		0-1.65-3.3V		
			C		-5-5V	0-5V	
			D		0-2.5-5V		
			E		-10-10V	0-10V	
			F		0-5V-10V		
				G	12V DC	4-12-20mA	4-20mA
				H		-3.3-3.3V	0-3.3V
				I		0-1.65-3.3V	
				J		-5-5V	0-5V
				K		0-2.5-5V	
				L		4-12-20mA	4-20mA

Example: **RTS01A-0.1-2000-C** means:
Model: RTS01A(With integrated display unit)
Power supply: 24V DC
Torque channel: -0.1Nm~0.1Nm VS -5-5V
Speed channel: 0~2000RPM VS 0-5V

Wiring code	
Red	Power+
Black	Power-
Green	Torque output+
Yellow	Speed output+
White	Output-
Bold Yellow	Shield

Order example:

Sensor: 1 x **RTS01A-2-6000-A**

Cable: 1 x **RTS01-5M-L**

Email to sales@loadcellsensor.com for a quote

